

DIMENSIONS

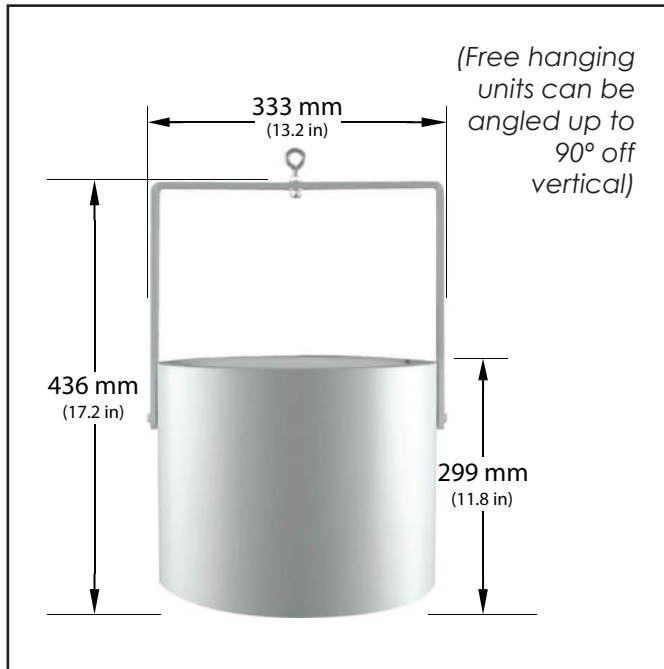

PUREAIR DESIGNER SERIES RANGE - MODEL 10 Short

DESCRIPTION

- Air purification and odour control destratification and airflow circulation fan.
- Features integrated Photohydroionization (PHI) Cell.
- Creates aggressive advanced oxidation atmosphere.
- Floods spaces with airborne hydroperoxides, superoxide and hydroxide ions.
- Broad spectrum HE/UV light targeted on a quad metallic target producing hydroperoxides.

FEATURES

- Kills surface Germs, Bacteria & Viruses by 99%+.
- Kills airborne Germs, Bacteria & Viruses by 97%+.
- Reduces Odours by 99%+.
- Reduces VOCs, gases & Vapours by 80%+.
- Balances internal building temperatures.
- Saves 20% - 50% on heating & cooling costs.

INGRESS PROTECTION

- IP55 Rated.

PROPERTIES

UNIT SIZE	SHORT	
	Weight:	5.4 kgs (12 lbs)
	Height to Rim:	299 mm (11.8 in)
	Total Height:	436 mm (17.2 in)
Diameter:	333 mm (13.2 in)	

MOTOR	230V @ 50 Hz	
	Watts*:	13.5
	RPM*:	868
	L/S*:	100 (213 CFM)
	m ³ /hr*:	361
	Centre Line Velocity*:	1.53 m/s @ 3 m
AMPS*:	0.06	

*Motor data provided by motor manufacturer and is subject to change at anytime

BULB	5" Cell	
	Length:	5" Cell
Wattage:	+9W	

COVERAGES	AIRFLOW	
	Ceiling Height:	Up to 3.5 m (11 ft)
	Nozzle Height:	Up to 3 m (10 ft)
Floor area:	Up to 46 m ² (500 ft ²)	
PURIFICATION		
5" PHI Cell:	271 m ³ (9,570 ft ³)	

*Coverages can vary dependent upon environment and load.

MOTOR

- Single phase, shaded pole, single speed (variable with optional speed control), axial motor.
- Sealed bearings, no lubrication required.



CELL PERFORMANCE

- 25,000 hours (3 yrs) estimated life of continuous runtime.

PROPERTIES

VELOCITY PROFILE

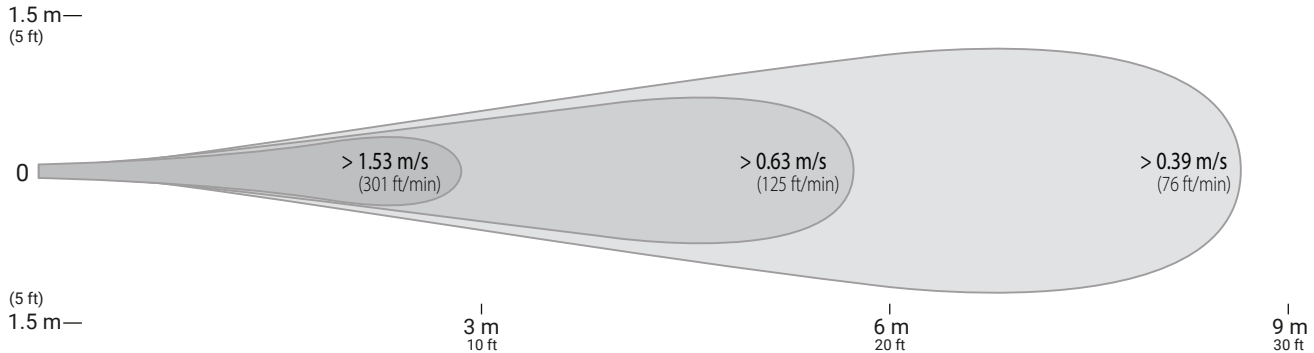

OPERATION

- Designed to operate 24 hours-a-day, 7 days-a-week to protect against airborne mould, bacteria, viruses, odours and VOCs and save heating & cooling costs.

OPERATING TEMPERATURES

- Operating Temp = -20°C (-4°F) to 70°C (158°F)

HOUSING & COMPONENTS

- Aluminium, powder coated cylindrical housing
- Internal PC/ABS resin fixed blade stator
- 5VA flame resistance rating.
- Hydrated catalytic matrix cell (Quad-Metallic).
- UV bulb encased in a protective poly tube & entire assembly is encased in a protective metal cell.
- Applicable to Titan Series Upgrade - Chemical resistant ABS resin housing and stator blades with stainless steel fixings

NOISE LEVEL

- Sound Pressure Level = 27.7 dB(A)

Calculated from nozzle of unit to head height when installed at maximum ceiling height.

For additional noise level information contact Airius

COLOUR

- White as standard.
- Can be tailor painted to your colour specifications.

MAINTENANCE

- No maintenance required.
- If the Photohydroionization Cell fails, contact manufacturer.

ACCESSORIES & OPTIONS

- Speed Controls - On/off speed controls allow for variable output from Airius unit. 1 AMP and 5 AMP controls available.

WARRANTY

- 3 years parts and workmanship from shipping date on fan unit.
- 1 years parts and workmanship from shipping date on Photohydroionization Cell.
- 120 day money back guarantee - UK only (T's & C's apply).

SAFETY PRECAUTIONS

- UV bulb is encased in a protective poly tube to prevent any glass or mercury breakage/leakage.

PLACEMENT

PREPARATION

- Install electrical circuit(s) and outlet(s) in accordance with national and local electric codes
- Outlets should generally be mounted vertically unless a "twist/locking" type is being used
- Wall switch may be installed in circuit to disable power and prevent electrical hazards when servicing
- Confirm electrical continuity of Airius unit on the ground before permanently mounting in the ceiling

INSTALLATION

- Hang vertically as high in the ceiling as possible
Typically 300mm (12") - 450mm (18") from the roof deck to intake
- The Airius unit performs best when air column from the nozzle is unimpeded to the floor
- Use professionally installed hardware, capable of supporting a minimum of five times the weight
- Hardware to hang the unit includes but is not restricted to: Hooks, chains, cables, carabiners, bridle rings, beam clamps and bolts
- Density of the placement is directly related to the effectiveness, performance and savings
- Mount out of reach from people and animals
- Floor plans, mezzanines, office locations, machinery, people placement, plumbing, lighting, duct work, electrical systems, natural light/air systems, cranes, doors, windows, ventilation and fire suppression systems are all factors in properly locating the Airius system within the ceiling
- Units must have a clearance distance between PHI cell and occupants of 30cm for 5 inch cell and 60cm for 9 inch cell
- Ensure UV safety goggles are worn when handling unit

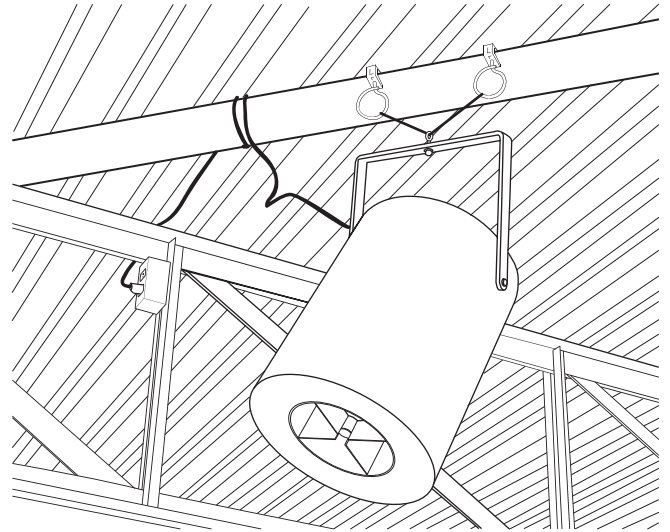

OPERATION

- Designed to operate 24 hours-a-day, 7 days-a-week to maintain thermal equalization/humidity equalization
- Use optional speed control to fine tune RPM if needed

MAINTENANCE

- Frequency of cleaning will vary by application and environment
- You may clean the plastic housing with a damp warm cloth, using mild household detergents
- Do not use petroleum products, thinners or solvents to clean any part of the Airius unit
- If the Airius unit fails, contact manufacturer

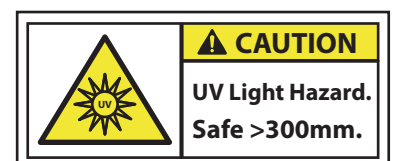

Airius LLC, © 2011. All Rights Reserved.